

KENWOOD

KRC-407
KRC-307S

CASSETTE RECEIVER
INSTRUCTION MANUAL

KENWOOD CORPORATION

Take the time to read through this instruction manual.

Familiarity with installation and operation procedures will help you obtain the best performance from your new Cassette-receiver.

For your records

Record the serial number, found on the back of the unit, in the spaces designated on the warranty card, and in the space provided below. Refer to the model and serial numbers whenever you call upon your KENWOOD dealer for information or service on the product.

Model KRC-407/307S Serial number

©B64-1319-00 (KW)



Contents

Before use

Warning	3
Safety precautions	4

Basic operations

Power	6
Switching Modes	6
Volume	6
Attenuator	7
Loudness	7

Tuner features

Tuning	8
Station Preset Memory	8
Auto Memory Entry	8
Clear Reception System Circuit (CRSC)	8
Clock display	9

Cassette player features

Playing Cassette Tapes	10
Fast Forwarding and Rewinding Cassette Tapes	10
Using Dolby B Noise Reduction	10
Switching Tape Types	10
Blank Skip	10
Tuner Call	11
Tape Advance	11
Music Repeat	11
Clock display	11

External disc control features

Playing Disc mode	12
Fast Forwarding and Reversing Disc Play	12
Track Search	13
Disc Search	13
Track / Disc Repeat	13
Track Scan	14
Disc Scan	14
Random Play	14
Magazine Random Play	14
Clock display	15

Other features

Audio Control Setting	16
Adjusting Time	16
Disabled System Indicator (DSI)	16
Theft Deterrent Facoplate	16

Installation

Accessories	18
Installation Procedure	18
Connecting Wires to Terminals	19
Installation	20

Troubleshooting guide.....23

Specifications.....26



Dear Customer:

Selecting fine audio equipment such as the unit you've just purchased is only the start of your musical enjoyment. Now it's time to consider how you can maximize the fun and excitement your equipment offers. This manufacturer and the Electronic Industries Association's Consumer Electronics Group want you to get the most out of your equipment by playing it at a safe level. One that lets the sound come through loud and clear without annoying blaring or distortion — and, most importantly, without affecting your sensitive hearing.

Sound can be deceiving. Over time your hearing "comfort level" adapts to higher volumes of sound. So what sounds "normal" can actually be loud and harmful to your hearing. Guard against this by setting your equipment at a safe level **BEFORE** your hearing adapts.

To establish a safe level:

- Start your volume control at a low setting.
- Slowly increase the sound until you can hear it comfortably and clearly, and without distortion.

Once you have established a comfortable sound level:

- Set the dial and leave it there.

Taking a minute to do this now will help to prevent hearing damage or loss in the future. After all, we want you listening for a lifetime.

We Want You Listening For A Lifetime

Used wisely, your new sound equipment will provide a lifetime of fun and enjoyment. Since hearing damage from loud noise is often undetectable until it is too late, this manufacturer and the Electronic Industries Association's Consumer Electronics Group recommend you avoid prolonged exposure to excessive noise. This list of sound levels is included for your protection.

Decible Level Example

30	Quiet library, soft whispers
40	Living room, refrigerator, bedroom away from traffic
50	Light traffic, normal conversation, quiet office
60	Air conditioner at 20 feet, sewing machine
70	Vacuum cleaner, hair dryer, noisy restaurant
80	Average city traffic, garbage disposals, alarm clock at two feet.

THE FOLLOWING NOISES CAN BE DANGEROUS UNDER CONSTANT EXPOSURE

90	Subway, motorcycle, truck traffic, lawn mower
100	Garbage truck, chain saw, pneumatic drill
120	Rock band concert in front of speakers, thunderclap
140	Gunshot blast, jet plane
180	Rocket launching pad

Information courtesy of the Deafness Research Foundation.



Safety precautions

▲WARNING

To prevent injury or fire, take the following precautions:

- Insert the unit all the way in until it is fully locked in place. Otherwise it may fall out of place when jolted.
- When extending the ignition, battery, or ground wires, make sure to use automotive-grade wires or other wires with a 0.75mm² (AWG18) or more to prevent wire deterioration and damage to the wire coating.
- To prevent a short circuit, never put or leave any metallic objects (such as coins or metal tools) inside the unit.
- If the unit starts to emit smoke or strange smells, turn off the power immediately and consult your Kenwood dealer.
- Make sure not to get your fingers caught between the faceplate and the unit.
- Be careful not to drop the unit or subject it to strong shock.
The unit may break or crack because it contains glass parts.
- Do not touch the liquid crystal fluid if the LCD is damaged or broken due to shock. The liquid crystal fluid may be dangerous to your health or even fatal.
If the liquid crystal fluid from the LCD contacts your body or clothing, wash it off with soap immediately.

▲CAUTION

To prevent damage to the machine, take the following precautions:

- Make sure to ground the unit to a negative 12V DC power supply.
- Do not open the top or bottom covers of the unit.
- Do not install the unit in a spot exposed to direct sunlight or excessive heat or humidity. Also avoid places with too much dust or the possibility of water splashing.
- Do not set the removed faceplate or the faceplate case in areas exposed to direct sunlight, excessive heat or humidity. Also avoid places with too much dust or the possibility of water splashing.
- To prevent deterioration, do not touch the terminals of the unit or faceplate with your fingers.
- Do not subject the faceplate to excessive shock, as it is a piece of precision equipment.
- When replacing a fuse, only use a new one with the prescribed rating. Using a fuse with the wrong rating may cause your unit to malfunction.
- To prevent a short circuit when replacing a fuse, first disconnect the wiring harness.
- Do not place any object between the faceplate and the unit.
- Do not use your own screws. Use only the screws provided. If you use the wrong screws, you could damage the unit.

IMPORTANT INFORMATION

You cannot connect the unit directly to the following CD automatic changers. If you want to use older changers with the unit, follow the directions below according to the type of changer you own:

- **KDC-C200 / KDC-C300 / KDC-C400**
Use the extension cable and the control box attached to the CD changer, and the optional CA-DS100 converter cord.
- **KDC-C301 / KDC-C600 / KDC-C800 / KDC-C601 / KDC-C401**
Use the extension cable attached to the CD changer, and the optional CA-DS100 converter cord.
- **KDC-C100 / KDC-C302 / C205 / C705 / non-Kenwood CD changers**
Cannot be used with this model.

▲CAUTION

You can damage both your unit and the CD changer if you connect them incorrectly.

FCC WARNING

This equipment may generate or use radio frequency energy. Changes or modifications to this equipment may cause harmful interference unless the modifications are expressly approved in the instruction manual. The user could lose the authority to operate this equipment if an unauthorized change or modification is made.

NOTE

- If you experience problems during installation, consult your Kenwood dealer.
- If the unit does not seem to be working right, try pressing the reset button first. If that does not solve the problem, consult your Kenwood dealer.

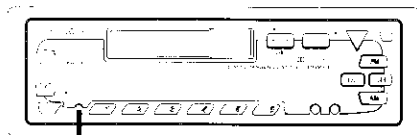

Reset button

- Characters in the LCD may become difficult to read in temperatures below 41°F (5°C).

Cleaning the Faceplate Terminals

If the terminals on the unit or faceplate get dirty, wipe them with a dry, soft cloth.

Cleaning the Unit

If the front panel gets dirty, turn off the power and wipe the panel with a dry, soft cloth or soft cloth.

▲ CAUTION

Do not wipe the panel with a hard cloth or a cloth dampened by volatile solvents such as paint thinner and alcohol. They can scratch the surface of the panel and/or cause the indicator letters to peel off.

Cleaning the Tape Head

After you have listened to many cassettes over a long period of time, magnetic powder from the tapes and dust accumulates on the tape head, causing noise and a deterioration in sound quality. Clean the tape head using a cleaning tape or cleaning kit designed for use in car audio systems.

Handling Cassette Tapes

- Do not play a cassette whose tape has gone slack. In such a case, wind it tight using a pencil or the index on one of the spools. Playing slack cassette tapes can result in the tape tangling around the capstan and/or pinch rollers, causing trouble.
- Do not play a deformed cassette or one whose labels are starting to come off, as it can cause the unit to malfunction.
- Do not leave tapes in hot places, such as on dashboards and other spots exposed to direct sunlight, or near heater outlets. They can deform the cassette.
- Avoid using extremely long cassette tapes, such as 100-minute-long tapes. Such tapes are very thin, and can tangle easily around the pinch rollers or other parts inside the unit, causing unit failure.
- Remove a cassette tape from the unit when not listening to it for a while. If you leave a tape in the unit too long, it may stick to the tape head and cause unit malfunction.

*Dolby noise reduction manufactured under license from Dolby Laboratories Licensing Corporation.
"DOLBY" and the double-D symbol are trademarks of Dolby Laboratories Licensing Corporation.*

Basic operations

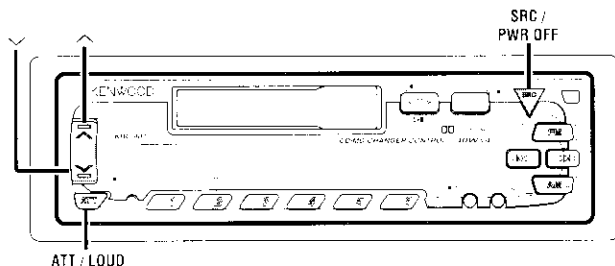

ATT indicator

ATT
LOUD

FML

92.1

12:35° 5_{ch}

LOUD indicator

Power

Turning on the power:

Press the SRC (source) button.

NOTE

Turn the power on before carrying out the following procedures.

Turning off the power:

Press the PWR OFF button for at least one second.

Switching Modes

Switching Modes:

Each time you press the SRC (source) button, the mode switches as follows

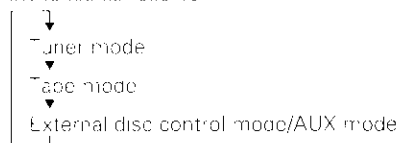

NOTE

- The mode switches to the next mode from any mode which cannot be used.
- The external disc control mode will differ depending on the unit that is connected.
- The AUX mode is available only when the AUX switching adapter (CA-C1AX) is connected to this unit.
During the AUX mode, 'AV in' will show in the display.
When the CA-C1AX is being used, the AUX Mode will replace the External Disc Control Mode.

Volume

Increasing Volume:

Tuner features

Press the \wedge button to turn up the volume.

Decreasing Volume:

Press the \vee button to turn down the volume.

Attenuator

This function allows you to turn down the volume quickly.

Turning Attenuator On/Off:

Press the ATT button to switch the attenuator on and off.

When the attenuator is on, the ATT indicator lights.

When the attenuator is off, the volume returns to the original level.

NOTE

Turning the volume all the way down deactivates the attenuator function.

Loudness

This function amplifies low and high tones when the volume is turned down.

The LOUD indicator lights up when the loudness function is on.

Turning Loudness On/Off:

Press the LOUD button for at least one second to switch the loudness on and off.

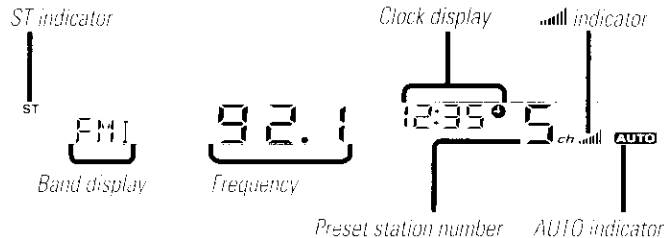
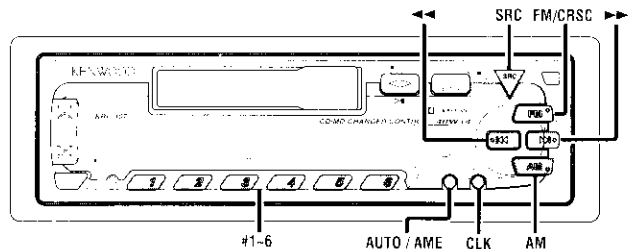

Tuner features

Tuning

You can choose between auto seek tuning of receivable frequencies and manual tuning.

- 1 Press the SRC (source) button repeatedly to select the tuner mode. TUN.F is displayed when the tuner mode has been selected.
- 2 Press either the FM or AM button to select the band. Each time you press the FM button, the band switches between FM1, FM2, and FM3 (which are used for groups of preset stations). Press the AM button to select the AM band.
- 3 Press the AUTO button to switch between auto seek tuning and manual tuning.
The AUTO indicator lights up only when auto seek tuning is selected.
- 4
 - Auto Seek Tuning
Press the ►► button to seek higher frequencies.
Press the ◀◀ button to seek lower frequencies.
 - Manual Tuning
Press the ►► button to increase the frequency by one step.
Press the ◀◀ button to decrease the frequency by one step.

NOTE

The ST indicator lights up when stereo broadcasts are being received.

Station Preset Memory

Store the frequency of a station. You can then recall that station with a single touch of a button.

- 1 Select the band/ station that you want to have stored.
- 2 Press the button (#1-6) that you want to use for the station, for at least two seconds.
The button number blinks once on the display to indicate that the data has been stored.

Recalling a Preset Station:

Press the preset station button (#1-6) for the desired station. The number of the recalled station is displayed.

NOTE

You can store six stations in each of the FM1, FM2, FM3, and AM bands.

Auto Memory Entry

You can automatically store all the receivable frequencies in the band currently being listened to, and then recall them with the touch of a button later. This function is especially useful when you are travelling and do not know what stations are available. Up to six frequencies can be stored this way.

- 1 Select the band for auto memory entry.
- 2 Press the AMF button for at least two seconds to start auto memory entry.
The numbers of the preset station buttons are shown in order. When all the stations in a certain band are stored in the preset memory, the auto memory entry stops. The tuner then plays the last station received.

Recalling a Preset Station:

Press the preset station button (#1-6) for the desired station. The number of the recalled station is displayed.

Clean Reception System Circuit (CRSC)

Temporarily have reception switched from stereo to mono to reduce multi-path noise when listening to the FM station. The factory default for this function is ON.

Turning CRSC On/Off:

Press the CRSC button for at least one second to turn the function on/off. The CRSC indicator is displayed when CRSC is on.

NOTE

Strong electrical fields (such as from power lines) may cause unstable sound quality when CRSC is turned on. In such a situation, turn it off.

Clock display

Turning clock display On/Off:

Press the CLK button to switch the clock display on and off. The  indicator lights while the clock is displayed.

Cassette player features

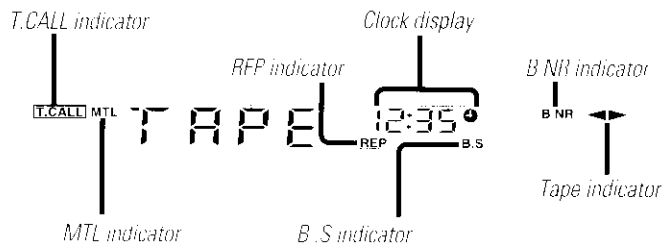
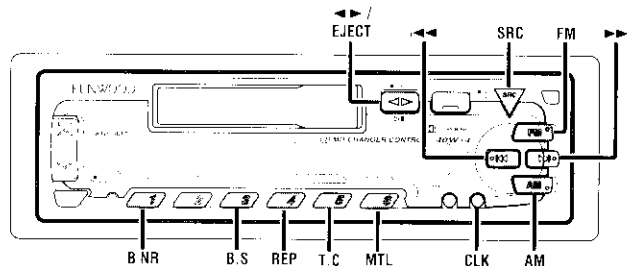

Cassette player features

Playing Cassette Tapes

Loading and Playing Cassettes:

Load a cassette with the tape exposed on the right.
The tape starts playing automatically.

Playing Cassettes Already Loaded:

Press the SRC (source) button repeatedly to select the tape mode. "TAPF" is displayed when the tape mode has been selected.

Listening to the other side:

Press the ◀▶ button.
Tape play switches to the other side.

Stopping and Ejecting Cassettes:

Press the ◀▶ button for at least one second.
The tape stops playing and the cassette ejects.

NOTE

Remove a cassette from the unit when not listening to it for a while. If you leave it in the unit too long, the tape may stick to the tape head and cause unit malfunction.

Fast Forwarding and Rewinding Cassette Tapes

Fast Forwarding Tapes:

Press the FF button.
The tape indicator blinks in the direction of the tape as it is being fast-forwarded.

Rewinding Tapes:

Press the AM button.
The tape indicator blinks in the direction of the tape as it is being rewound.

Canceling:

Press the ◀▶ button.
Normal tape play will begin.

Function of the KRC 407

Using Dolby B Noise Reduction

Listen to tapes recorded using Dolby B NR.

Turning Dolby B Noise Reduction On/Off:

Press the B NR button to switch Dolby B NR on and off.
The B NR indicator lights up when it is turned on.

Function of the KRC-407

Switching Tape Types

Select type of tape being played.

Switching Tape Types:

Press the MTL (Metal) button to switch the meta tape indicator on and off and to select the tape type.
Turn the MTL indicator off for normal tape (Type II) playback.
Turn the MTL indicator on for the following tape types:
CrO (Type I) FeCr (Type II) Metal (Type IV)
Selecting the wrong tape type may cause sound quality to suffer.

Blank Skip

Automatically fast forward to the beginning of the next track when long blank spaces (10 seconds or more) are detected, continuing tape playback. The B.S indicator lights up when blank skip is turned on.

Turning Blank Skip On/Off:

Press the B.S button to switch blank skip on and off.

NOTE

- If the blank space contains much noise, the blank skip function may not work right.
- Sections recorded at low levels may trigger the blank skip function if they last for 10 seconds or more.

Tuner Call

Switch automatically to the tuner while you are rewinding or fast forwarding the tape.

Turning Tuner Call On/Off:

Press the T.C button to switch tuner call on and off.

The T CALL indicator lights up when tuner call is turned on.

NOTE

When you turn on the Tuner Call function, the motorised antenna will extend automatically.

Tape Advance

Rewinds to the beginning of the track currently being listened to (or fast forwards to the beginning of the next track), continuing tape playback.

Rewinding tape to the beginning of current track:

Press the ◀◀ button, and the tape will rewind to the beginning of the current track and automatically start playing again.

To advance to the beginning of the next track:

Press the ▶▶ button, and the tape will advance to the beginning of the next track and automatically start playing again.

NOTE

Tape advance "knows" where a track begins by detecting the blank space preceding it (the space between tracks). However, when the blank space lasts for less than four seconds or contains noise, this function may not operate correctly. Furthermore, sections that are recorded at low levels may trigger the function if they last for four seconds or more.

Music Repeat

Repeatedly plays the track currently being listened to.

Turning Music Repeat On/Off:

Press the REP button to switch music repeat on/off.

The REP indicator lights up when music repeat is turned on.

Canceling Music Repeat:

Press either the REP or ◀▶ button.

NOTE

Music repeat "knows" where a track begins by detecting the blank space preceding it (the space between tracks). However, when the blank space lasts for less than four seconds or contains noise, this function may not operate correctly. Furthermore, sections that are recorded at low levels may trigger the function if they last for four seconds or more.

Clock display

Turning clock display On/Off:

Press the CLK button to switch the clock display on and off.

The ⌚ indicator lights while the clock is displayed.

External disc control features

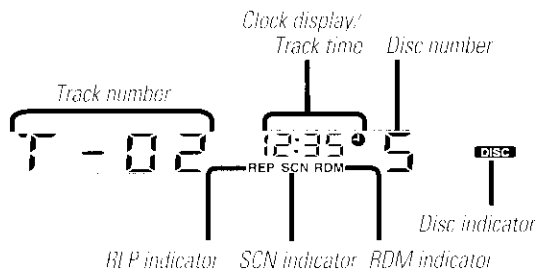
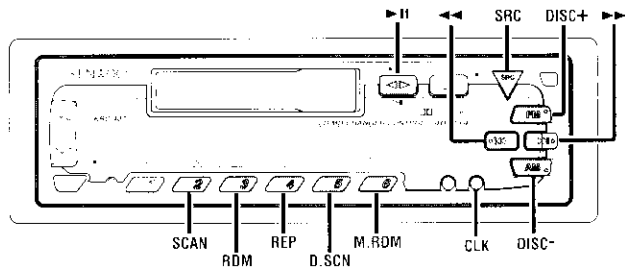

Playing Disc mode

This function permits the connection of optional players and the playing of discs.

Playing Discs:

Press the SRC button repeatedly to select the external disc control mode.

The disc will start playing.

NOTE

The external disc control mode will differ, depending on the unit that is connected.

Mode Display Examples

- DISC ... when a disc changer is connected

Pausing and Restarting Disc Play:

Press the ►|| button to make the disc pause.

Press the same button again to start play again.

NOTE

- When one disc has finished playing its last track, the next disc in the changer starts playing. When the last disc in the changer has finished, the player returns to the first disc and starts playing it.
- Disc #10 is displayed as '0'.

Fast Forwarding and Reversing Disc Play

Fast Forwarding Disc Play:

Hold down on the ►► button.

Release your finger to play the disc at that point.

Reversing Disc Play:

Hold down on the ◀◀ button.

Release your finger to play the disc at the point.

NOTE

You cannot use reverse play between tracks depending on the model being connected. Instead, the reverse play function is

canceled when 1 reaches the beginning of a track, at which point normal play will automatically resume.

Track Search

Search forward or backward through the tracks on the disc until you reach the one that you want to listen to.

Making a Reverse Track Search:

- Press the ◀◀ button to display the desired track number.
- Press once to search back to the beginning of the current track, twice to search back to the beginning of the previous track, and so forth.
- Play starts at the beginning of the displayed track number.

NOTE (For disc changers)

Pressing the ◀◀ button while listening to track 1 will only search back to the beginning of that track. The reverse search is not 'recycled' to the last track on the disc.

Making a Forward Track Search:

- Press the ▶▶ button to display the desired track number.
- Press once to fast forward to the next track, twice to fast forward to the track after that, and so forth.
- Play starts at the beginning of the displayed track number.

NOTE (For disc changers)

You cannot make a forward track search when listening to the last track on a disc.

Disc Search

Search forward or backward through the discs in a disc changer.

Making a Reverse Disc Search:

- Press the DISC- button to display the desired disc number.
- Each time the button is pressed, the displayed disc number decreases by one.

Play starts at the beginning of the displayed disc.

Making a Forward Disc Search:

- Press the DISC+ button to display the desired disc number.
- Each time the button is pressed, the displayed disc number increases by one.
- Play starts at the beginning of the displayed disc.

NOTE

'T.OAd' is displayed when discs are being exchanged on the disc changer.

Track / Disc Repeat

Repeat playing the track or the disc currently being listened to.

Turning Repeat Play On/Off:

Press the REP button to switch repeat track/disc play on and off as follows:

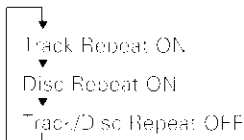

The REP indicator lights up when repeat play is turned on.
The track number blinks in the display when track repeat is on.
The disc number blinks in the display when disc repeat is on.

NOTE

Repeat play is canceled when you stop playing the disc.

External disc control features

Track Scan

Successively play the beginning of each track on a disc until you find the track that you want to listen to.

Starting the Track Scan :

Press the SCAN button. The SCN indicator lights up and the first 10 seconds of each track will be played, in order.

The track number currently being heard blinks in the display.

Stopping to Listen to the Track Being Scanned:

Press the ►II or SCAN button again to stop the scan and keep on listening to a track normally.

NOTE

- The track scan function is canceled when you stop playing a disc.
- The track scan function only scans each track on a disc once.

Disc Scan

Successively play the beginning of each disc on a changer until you find the one that you want to listen to.

Starting the disc scan:

Press the D.SCN button. The SCN indicator lights up and the first 10 seconds of each disc will be played, in the order they are loaded on the changer.

The disc number currently being heard blinks in the display.

Stopping to Listen to the Disc Being Scanned:

Press the ►II or D.SCN button again to stop the scan and keep on listening to the disc normally.

NOTE

- The disc scan function is canceled when you stop playing a disc.
- The disc scan function only scans each disc on the changer once.
- "LOAD" is displayed when discs are being exchanged on the disc changer.

Random Play

Play all the tracks on the current disc in random order.

- 1 Press the RDM button to switch random play on and off. The RDM indicator lights up when random play is turned on. The track number will change over and over in the display as the next track is being selected. When the track has been selected, play will begin. The selected track number blinks in the display as it is being played.

NOTE

When all the tracks on a certain disc have been played using random play, the next disc on the changer will start playing using the same function.

- 2 To change the track being heard, press the ►► button. Another track will be selected and played.

NOTE

Random play is canceled when you stop playing a disc.

Magazine Random Play

Play the tracks on all the discs in the disc changer in random order.

- 1 Press the V.RDM button to switch magazine random play on and off. The RDM indicator lights up when magazine random play is turned on. The disc and track numbers will change over and over in the display as the next track is being selected. When the disc/track has been selected, play will begin. The selected disc/track number blinks in the display as it is being played.

NOTE

This function is not available with the following models:
KDC-C200/C300/C400/C301/C401

- 2 To change the track being heard, press the **▶▶** button.
Another disc/track will be selected and played.

NOTE

- Magazine random play is canceled when you stop playing a disc.
- The time needed for random selection depends on the number of discs loaded in the disc magazine.

Clock display

Switching to the Clock display :

Each time you press the CLK button, the display switches between the Track time and Clock.

NOTE

The **⏻** indicator lights while the clock is displayed.

Other features

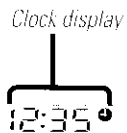
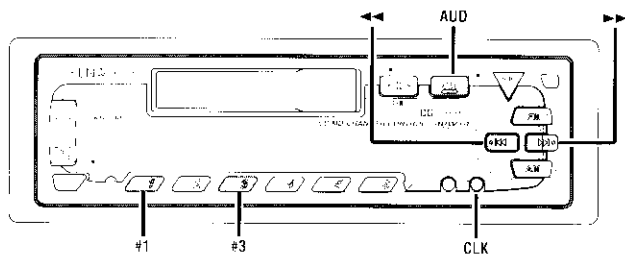

Other features

Audio Control Setting

Adjust various parameters of sound quality.

- 1 Press the **AJD** button to enter the control mode.
- 2 Press either the **FM** or **AM** button.
Each time the button is pressed, the adjustment mode will change as follows:
Pressing the **FM** button advances the display, and pressing the **AM** button reverses it.

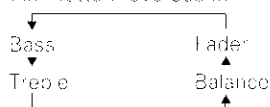

NOTE Source tone memory

Each source (tape, FM, AM and disc changer) has its own memory in which to store the bass and treble tone settings. The settings made for a particular source are recalled automatically whenever you use that source (for example, FM mode uses the tone settings made for FM, AM for AM, etc.).

- 3 Press the **◀◀/▶▶** button.
Look at the table to adjust the mode being displayed.

Adjustment mode (Display)	Operation of Audio control button	
	◀◀ button	▶▶ button
Bass ("BAS")	Bass decreased.	Bass increased.
Treble ("TRE")	Treble decreased.	Treble increased.
Balance ("BL")	Left channel emphasized.	Right channel emphasized.
Fader ("FD")	Rear channel increased.	Front channel increased.

- 4 Press the **AJD** button to end the control mode.

Adjusting Time

Adjust the time.

- 1 When the time is not displayed, first press the **CLK** button to display the time.
- 2 While holding down the **CLK** button, press the **◀◀** or **▶▶** buttons to adjust the time.
The **◀◀** button adjusts the hour and the **▶▶** button adjusts the minutes.

Disabled System Indicator (DSI)

A red indicator will blink on the unit after the faceplate is removed, warning potential thieves. The factory default for this function is ON.

Turning Disabled System Indicator On/Off:

- 1 Turn the power of the unit off.
- 2 While pressing buttons #1 and #3 at the same time, press the **SRC** button.

Repeat steps 1 and 2 above to turn DSI back on.

Theft Deterrent Faceplate

The faceplate of the unit can be detached and taken with you, helping to deter theft.

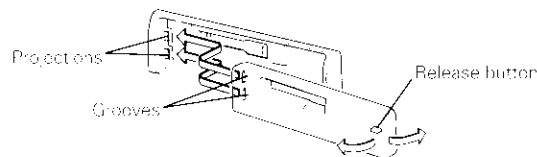

Removing the Faceplate:

Press the release button.

The faceplate is unlocked, allowing you to detach it.

NOTE

- The faceplate is a precision piece of equipment and can be damaged by shocks or jolts. For that reason, keep the faceplate in its special storage case while detached.

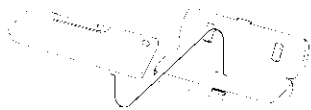





- Do not expose the faceplate or its storage case to direct sunlight or excessive heat or humidity. Also avoid places with too much dust or the possibility of water splashing.

Reattaching the Faceplate:

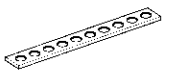
- 1 Align the projections on the unit with the grooves on the faceplate.
- 2 Push the faceplate in until it clicks.
The faceplate is locked in place, allowing you to use the unit.

Accessories

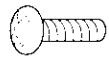
	External view	Number of items
1	1
2	1
3	2
4	1
5	4
6	4
7	1

CAUTION

The use of any accessories except for those provided might result in damage to the unit. Make sure only to use the accessories shipped with the unit, as shown above.

Installation Procedure

1. To prevent a short circuit, remove the key from the ignition and disconnect the - battery.
2. Make the proper input and output wire connections for each unit.
3. Connect the speaker wires of the wiring harness.
4. Connect the wiring harness wires in the following order: ground, battery, ignition.
5. Connect the wiring harness connector to the unit.
6. Install the unit in your car.
7. Reconnect the - battery.
8. Press the reset button.

CAUTION

- If your car's ignition does not have an ACC position, connect the ignition wires to a power source that can be turned on and off with the ignition key. If you connect the ignition wire to a power source with a constant voltage supply, as with battery wires, the battery may die.
- If the console has a lid, make sure to install the unit so that the faceplate will not hit the lid when closing and opening.
- If the fuse blows, first make sure the wires aren't touching to cause a short circuit, then replace the old fuse with one with the same rating.
- Do not let unconnected wires or terminals touch metal on the car or anything else conducting electricity. To prevent a short circuit, do not remove the caps on the ends of the unconnected wires or the terminals.
- Connect the speaker wires correctly to the terminals to which they correspond. The unit may be damaged or fail to work if you share the - wires or ground them to any metal part in the car.
- After the unit is installed, check whether the brake lamps, blinkers, wipers, etc. on the car are working properly.
- Insulate unconnected wires with vinyl tape or other similar material.
- Some disc changers need conversion cords for connection. See the section on 'Safety Precautions' for details.

Connecting Wires to Terminals

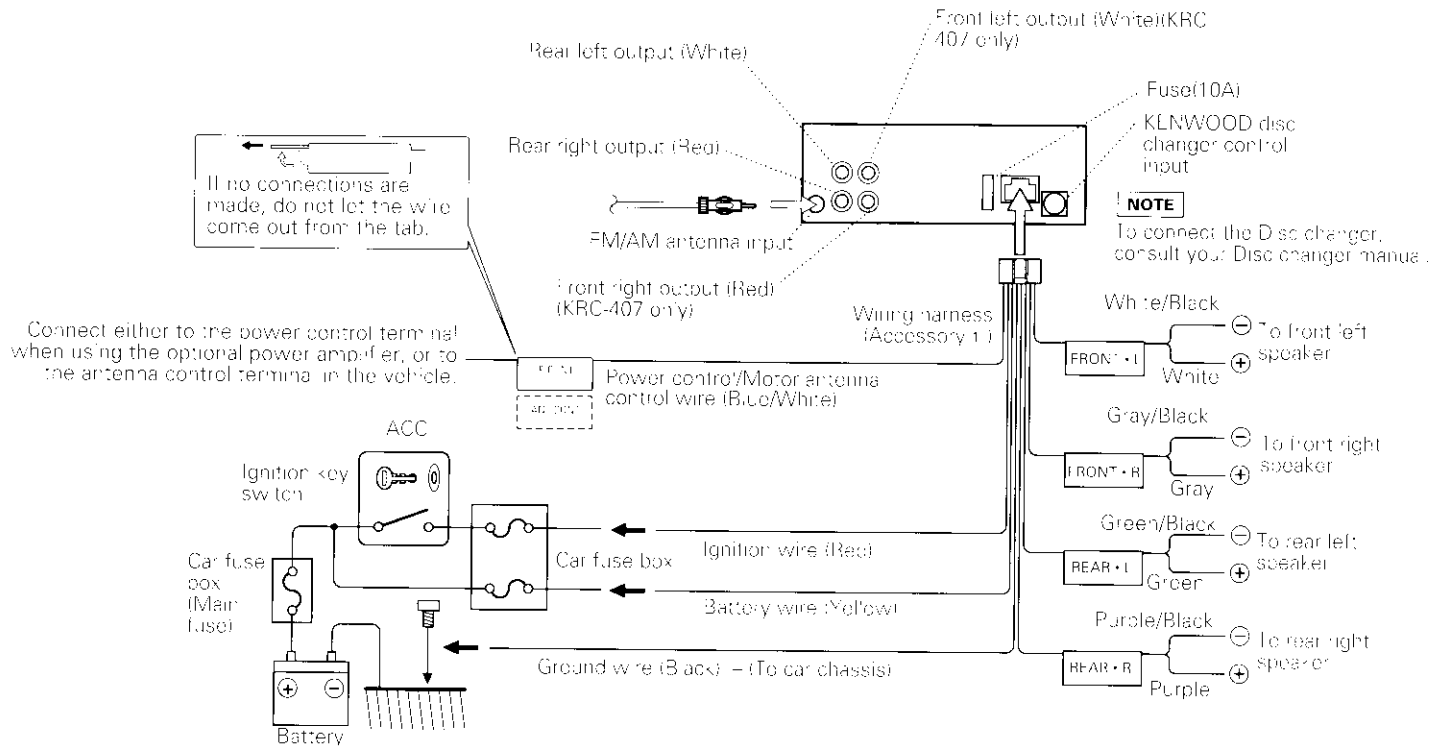

⚠ WARNING

If you connect the ignition wire (red) and the battery wire (yellow) to the car chassis (ground), you may cause a short circuit, that in turn may start a fire. Always connect those wires to the power source running through the fuse box.

⚠ CAUTION

When only two speakers are being connected to the system, connect the connectors either to both the front output terminals or to both the rear output terminals (do not mix front and rear). For example, if you connect the + connector of the left speaker to a front output terminal, do not connect the - connector to a rear output terminal.

■ Installation

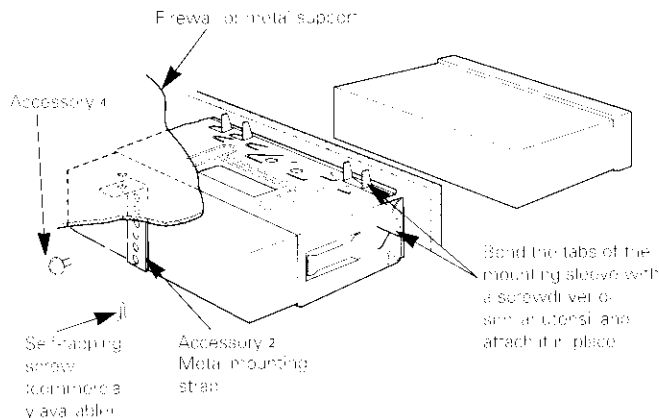

NOTE

Make sure that the unit is installed securely in place. If the unit is unstable, it may malfunction (for example, the sound may skip).

■ Installing in Japanese-Made Cars

- 1 Refer to the section "Removing the hard rubber frame (P. 21)" and then remove the hard rubber frame.
- 2 Align the holes in the unit (two locations on each side) with the vehicle mounting bracket and secure the unit with the accessory screws.

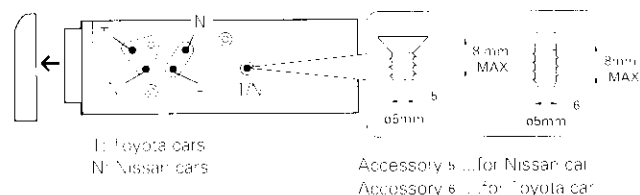

CAUTION

- During installation, do not use any screws except for those provided. The use of different screws might result in damage to the main unit.
- Damage may occur if a screwdriver or similar tool is used with excessive force during the installations.

■ Removing the hard rubber frame

- 1 Engage the catch pins on the removal tool and remove the two locks on the lower level.
Lower the frame and pull it forward as shown in the figure.

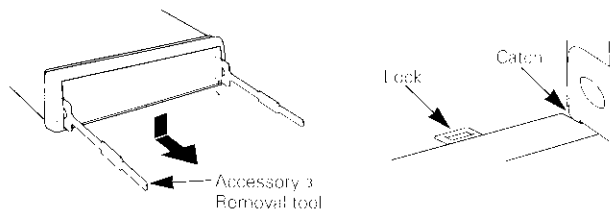

- 2 When the lower level is removed, remove the upper two locations.

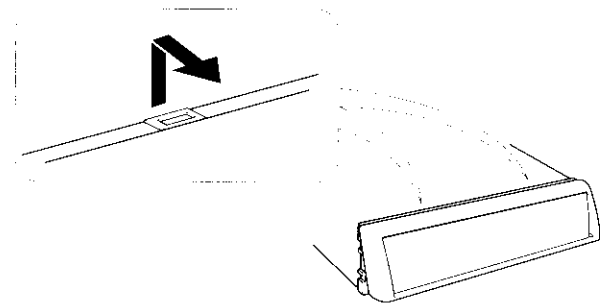

NOTE

The frame can be removed from the top side in the same manner.

■ Removing the Unit

- 1 Refer to the section "Removing the hard rubber frame (P. 21)" and then remove the hard rubber frame.
- 2 Remove the Hex-head screw with integr. washer (M4x8) on the back panel.
- 3 Insert the two removal tools deeply into the slots on each side, as shown.

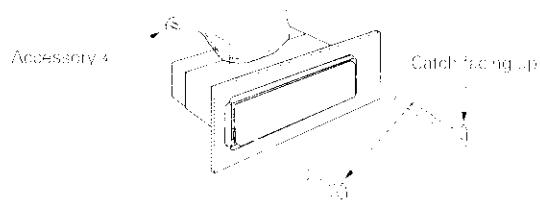

- 4 Lower the removal tool toward the bottom, and pull out the unit halfway whilst pressing towards the inside.

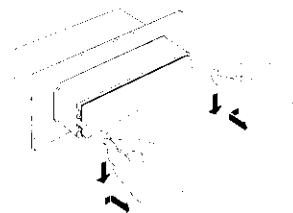

CAUTION

Be careful to avoid injury from the catch pins on the removal tool.

- 5 Pull the unit all the way out with your hands, being careful not to drop it.

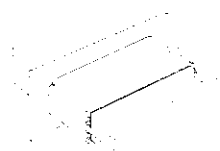

Installation

■ Screwing the Faceplate on the Unit

If you want to fasten the faceplate to the main unit so that it does not fall off, screw in the provided screw (ø4 × 16 mm) in the hole shown below.

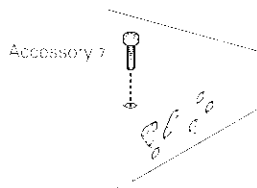

CAUTION

Never insert the taprite screw (ø4 × 16 mm) in any other screw hole than the one specified. If you screw it in another hole, it will contact and may cause damage to the mechanical parts inside the unit.

Troubleshooting Guide

What might seem to be a malfunction in your unit may just be the result of slight misoperation or miswiring. Before calling service, first check the following table for possible problems.

PROBLEM	POSSIBLE CAUSE	SOLUTION
The power does not turn on.	The fuse has blown.	After checking for short circuits in the wires, replace the fuse with one with the same rating.
No sound can be heard, or the volume is low.	Attenuator is turned on.	Turn off Attenuator.
	The fader or balance settings are set all the way to one side.	Reset the fader or balance settings.
	The input/output wires or wiring harness are connected incorrectly.	Reconnect the input/output wires or the wiring harness correctly. See the section on "Connecting Wires to Terminals."
	The cassette tape is bad.	Try playing another cassette tape. If works fine, the first tape was bad.
	The cassette tape is not loaded properly.	If the tape not start to play when a cassette tape is inserted, eject it and try inserting it again.
The tape does not go in / No sound can be heard even though the tape display is made.	The car ignition was turned off during tape eject; or the tape was pulled out during loading, switching the mode to tape mode even though no tape is in.	Press the Eject button.
Nothing happens when the buttons are pressed.	The computer chip in the unit is not functioning normally.	Press the reset button on the unit (see p. 5).
The sound quality is poor or distorted.	The tape head is dirty.	Clean the tape head, referring to the section on "Cleaning the Tape Head" (see p. 5).
	One of the speaker wires is being pinched by a screw in the car.	Check the speaker wiring.
	The speakers are not wired correctly.	Reconnect the speaker wires so that each output terminal is connected to a different speaker.
Radio reception is poor.	The car antenna is not extended.	Pull the antenna out all the way.
	The antenna control wire is not connected.	Connect the wire correctly, referring to the section on "Connecting Wires to Terminals."
The memory is erased when the ignition is turned off.	The battery wire has not been connected to the proper terminal.	Connect the wire correctly, referring to the section on "Connecting Wires to Terminals."
	The ignition and battery wire are incorrectly connected.	Connect the wire correctly, referring to the section on "Connecting Wires to Terminals."

Troubleshooting Guide

External disc control mode

PROBLEM	POSSIBLE CAUSE	SOLUTION
The disc control mode cannot be selected.	No cable has been connected to the disc changer input terminal on the unit.	Connect the cable to the disc changer input terminal on the unit.
The specified disc does not play, but another one plays instead.	The specified CD is quite dirty. The CD is upside down. The disc is loaded in a different slot from that specified. The disc is severely scratched.	Clean the CD. Load the CD with the label side up. Eject the disc magazine and check the number for the specified disc. Try another disc instead.
The sound skips.	Something is touching the disc changer. The CD is scratched or dirty.	Remove whatever is touching it. If skipping happens at the same place when the car is stopped, something with the CD is wrong. Clean the CD.
The display shows that the changer is being played, but no sound can be heard.	The computer chip in the unit is not functioning normally.	Press the reset button on the unit (see p. 6).
The specified track will not play.	Random play or magazine random play has been selected.	Turn off random play or magazine random play.

If the following situations, consult your nearest service center:

- Even though the disc changer is connected, the Disc Changer Mode is not on, with "AV" showing in the display during the Changer Mode.
- Even though no device (KCA-S210A, CA-C1AX, KDC-CPS82 or KDC-CX82i) is connected, the AUX Mode is entered when switching modes.

The following messages are displayed when certain problems are occurring in your system. Take the recommended actions.

- E-01 No disc magazine has been loaded in the changer. The disc magazine is not completely loaded.
⇒ Load the disc magazine properly.
No CD in the unit.
⇒ Insert the CD.
- E-02 No disc has been loaded in the disc magazine.
⇒ Load a disc into the disc magazine.
No CD in the unit.
⇒ Insert the CD.
- E-04 No disc has been loaded in the disc magazine.
⇒ Load a disc into the disc magazine.
The CD is quite dirty. The CD is upside-down. The CD is scratched a lot.
⇒ Clean the CD and load it correctly.
- E-10 Nothing has been recorded on the MD.
⇒ The next MD will automatically be played.
- E-11 No tracks are recorded on the MD, although it has a title.
⇒ The next MD will automatically be played.
- E-30 The faceplate of the slave unit being connected to this unit has been removed.
⇒ Replace it.
- E-77 The unit is malfunctioning for some reason.
⇒ Press the reset button on the unit. If the "E-77" code does not disappear, consult your nearest service center.
- E-99 Something is wrong with the disc magazine. Or the unit is malfunctioning for some reason.
⇒ Check the disc magazine. And then press the reset button on the unit. If the "E-99" code does not disappear, consult your nearest service center.
- F-0d The protective circuit in the unit activates when the temperature inside the automatic disc changer exceeds 60°C (140°F), stopping all operation.
⇒ Cool down the unit by opening the windows or turning on the air conditioner. As the temperature falls below 60°C (140°F), the disc will start playing again.
- ◀▶ If this indicator continues blinking, it is possible that the tape has become jammed or tangled.
⇒ Contact the Kenwood dealer if the cassette tape cannot be ejected.

Specifications

Specifications subject to change without notice.

FM tuner section

Frequency Range (200 kHz Spaced)	87.9 MHz -107.9 MHz
Usable Sensitivity (S/N: 30dB)	9.3 dBf (0.8 μ V/5 Ω)
Quieting Sensitivity (S/N: 50dB)	15.2 dBf (1.6 μ V/5 Ω)
Frequency Response (\pm 3.0dB)	30 Hz -15 kHz
Signal to Noise ratio	70 dB (V/CNO)
Selectivity	> 80 dB @ 400 kHz
Stereo Separation	40 dB @ 1 kHz

AM tuner section

Frequency Range (10 kHz spaced)	530 kHz -1700 kHz
Usable Sensitivity (S/N: 20 dB)	28 dBf (25 μ V)

Cassette player section

Tap Speed	4.76 cm/sec
Wow & Flutter	0.08 % (W/RMS)
Frequency response (\pm 3 dB):	
(KRC-407: 70 μ V)	30 Hz -18 kHz
(KRC-307S: 120 μ V)	30 Hz -14 kHz
Separation	43 dB @ 1 kHz
Signal to Noise ratio (KRC-407):	
(Dolby NR OFF)	57 dB
(Dolby B NR ON)	65 dB
Signal to Noise ratio (KRC-307S)	54 dB

Audio section

Preout Level (mV/Load)	1800 mV/10 k Ω
Preout Impedance	< 600 Ω
Maximum output power	
(KRC-407)	40 W x 4
(KRC-307S)	35 W x 4
Full Bandwidth Power (at less than 1% THD):	
(KRC-407)	20 W x 4
(KRC-307S)	18 W x 4
Tone action	
Bass	100 Hz \pm 10 dB
Treble	10 kHz \pm 10 dB

General

Operating voltage (1" - 16V allowable)	14.4 V
Current Consumption	10 A
Installation Size (W x H x D)	182 x 53 x 155 mm
	7-3/16 x 2 1/16 x 6 1/8 in
Weight	3.3 lbs (1.4 kg)